

58.934.00..0099

SANIT WC connection set DN90 with rat blocker

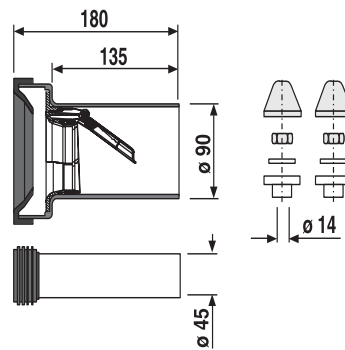

Item number

58.934.00..0099

Product description

WC connection set DN 90 with rat blocker
 in black PE plastic, weldable, l = 180 mm, DN 90 drain connector with
 built-in mechanical rat blocker, rear side of valve clad with bite-
 resistant stainless steel, prevents the invasion of foreign objects to
 the WC, inlet pipe with d:45 mm with flush pipe connector, M12 fastening
 set, chromium-plated cover-up accessories, for wall-hung WCs with
 concealed cistern, packed in a box
 tested to DIN 1389, DIN EN 997, 5.2.6 and DIN EN 476, 5.5