

25.009.00..0000

SANIT Universal fill valve 510 U G3/8

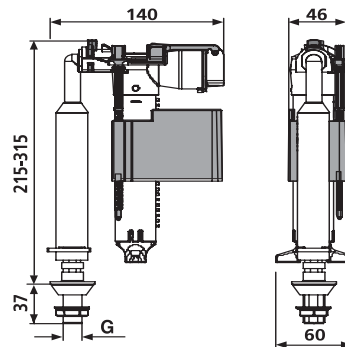
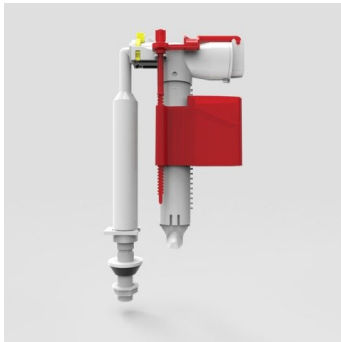

Item number

25.009.00..0000

Product description

Universal fill valve 510 U
size: G 3/8

small compact construction, rapid filling rate of 3.6 l/min at 0.5 bar flow pressure, quick closing, extremely quiet, only 13 dB(A)(Noise Class I), easy to install and maintain due to simple snap and plug connection, adjustable flush water volume controlled via continuously variable float, with telescopic pipe, plastic connection, for use in ceramic cisterns with bottom water inlet, packed in a plastic bag