

11.027.00..0099

SANIT ventilair two-way vent valve DN 30-50

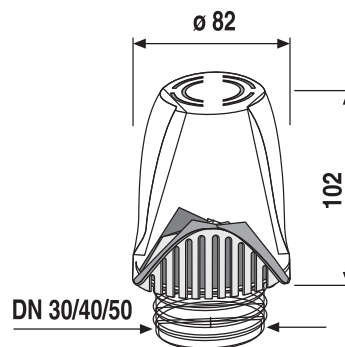

Item number

11.027.00..0099

Product description

ventilair duplex two-way vent valve suitable for DN 30/40/50
volume flow 8 l/s, temperature range -20degC to +60degC, with activated carbon filter, polystyrene frost protection cover and rubber connector for the stated dimensions

Notes:

ventilair duplex two-way vent valves are subjected to regular internal testing in accordance with DIN EN 12380. They do not comply with the standards DIN 1986-100 and DIN EN 12056-2, thus installation should be governed by a contractual agreement.